

JENHORSI,

WASCHKÜCHE UND HOLZSTALL.

M. 1:100.

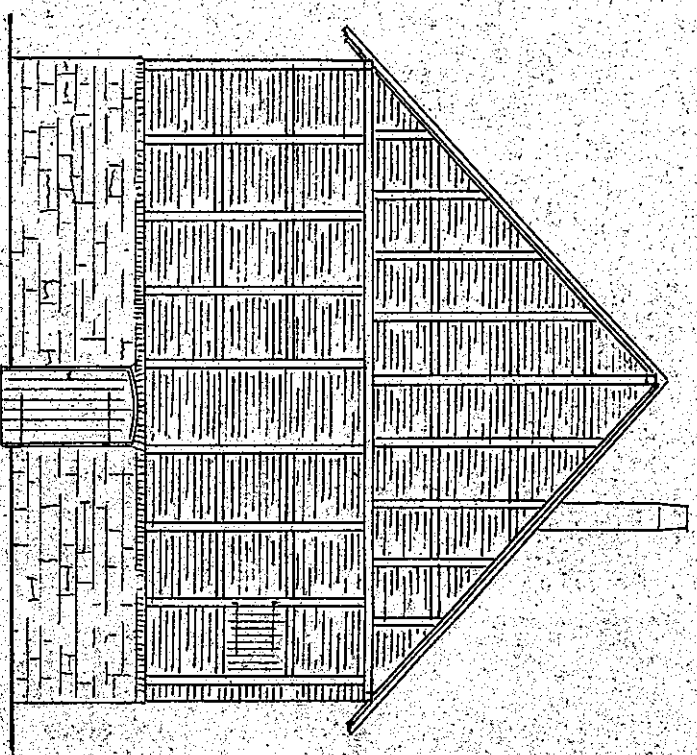

NORDWESTSEITE

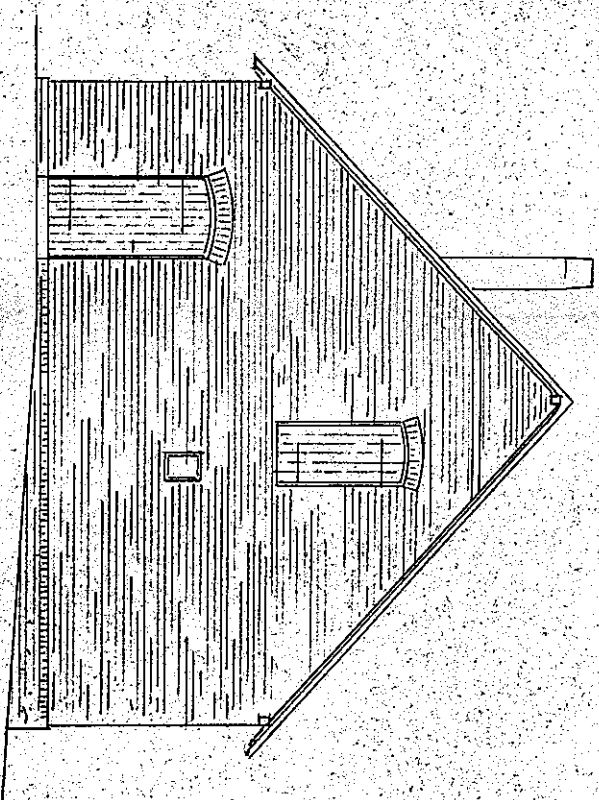

SÜDWESTSEITE

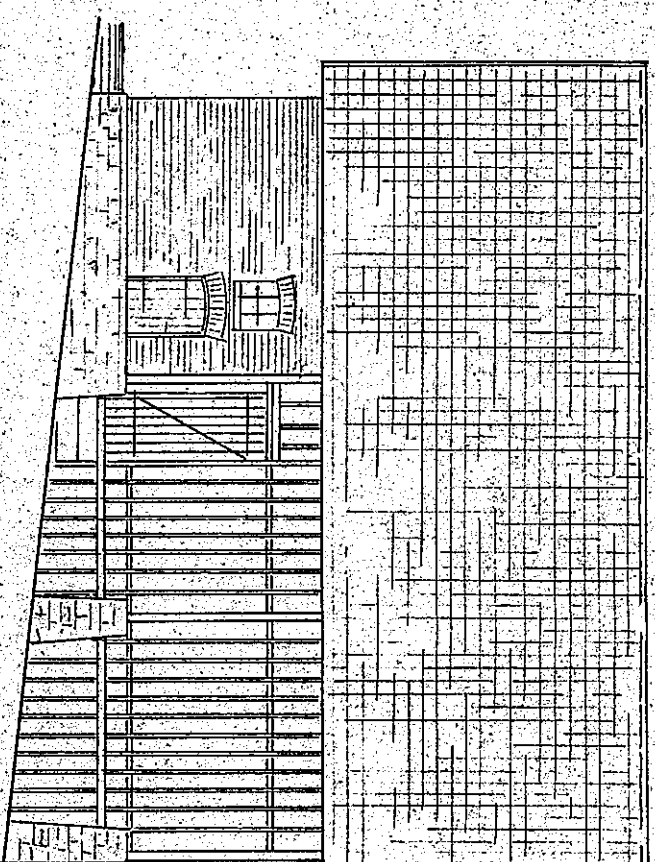

NORDOSTSEITE

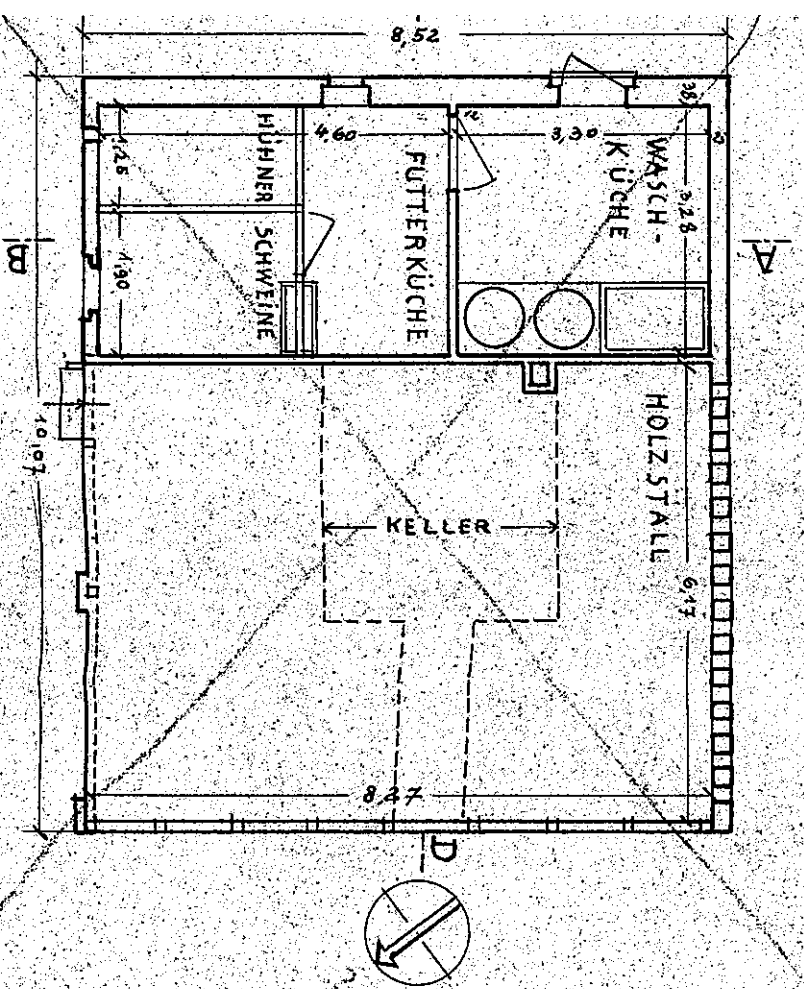

GRUNDRISS ÜBERHOHT

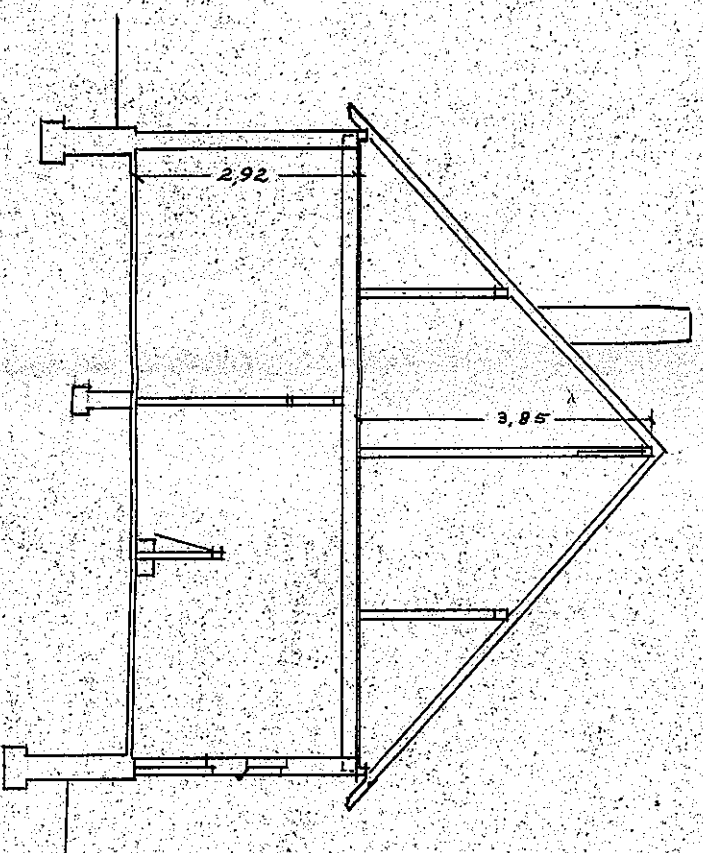

SCHNITT A-B

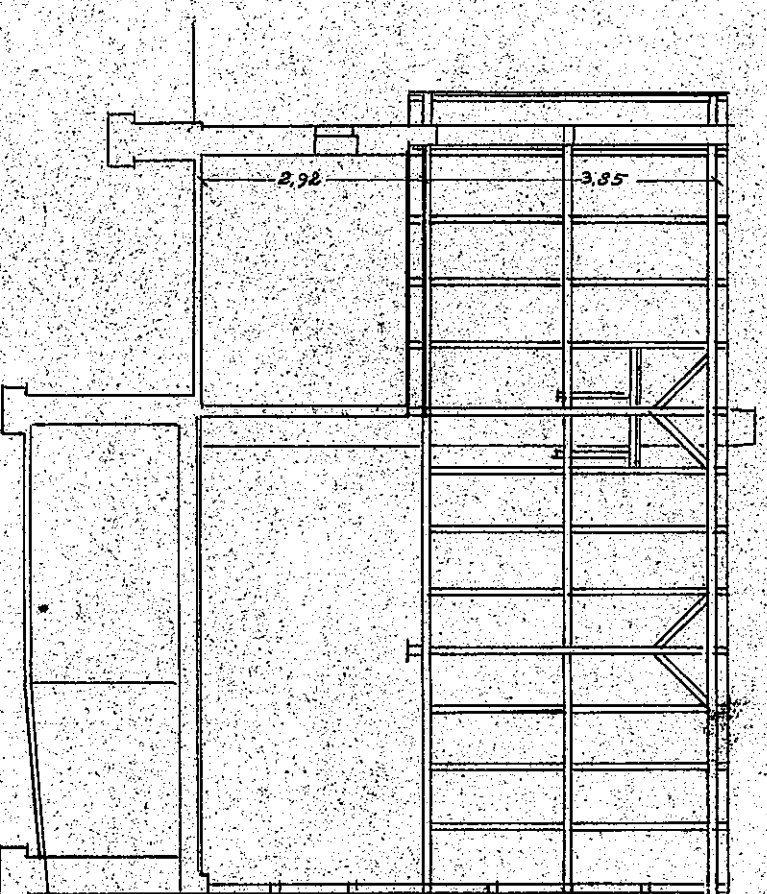

SCHNITT C-D

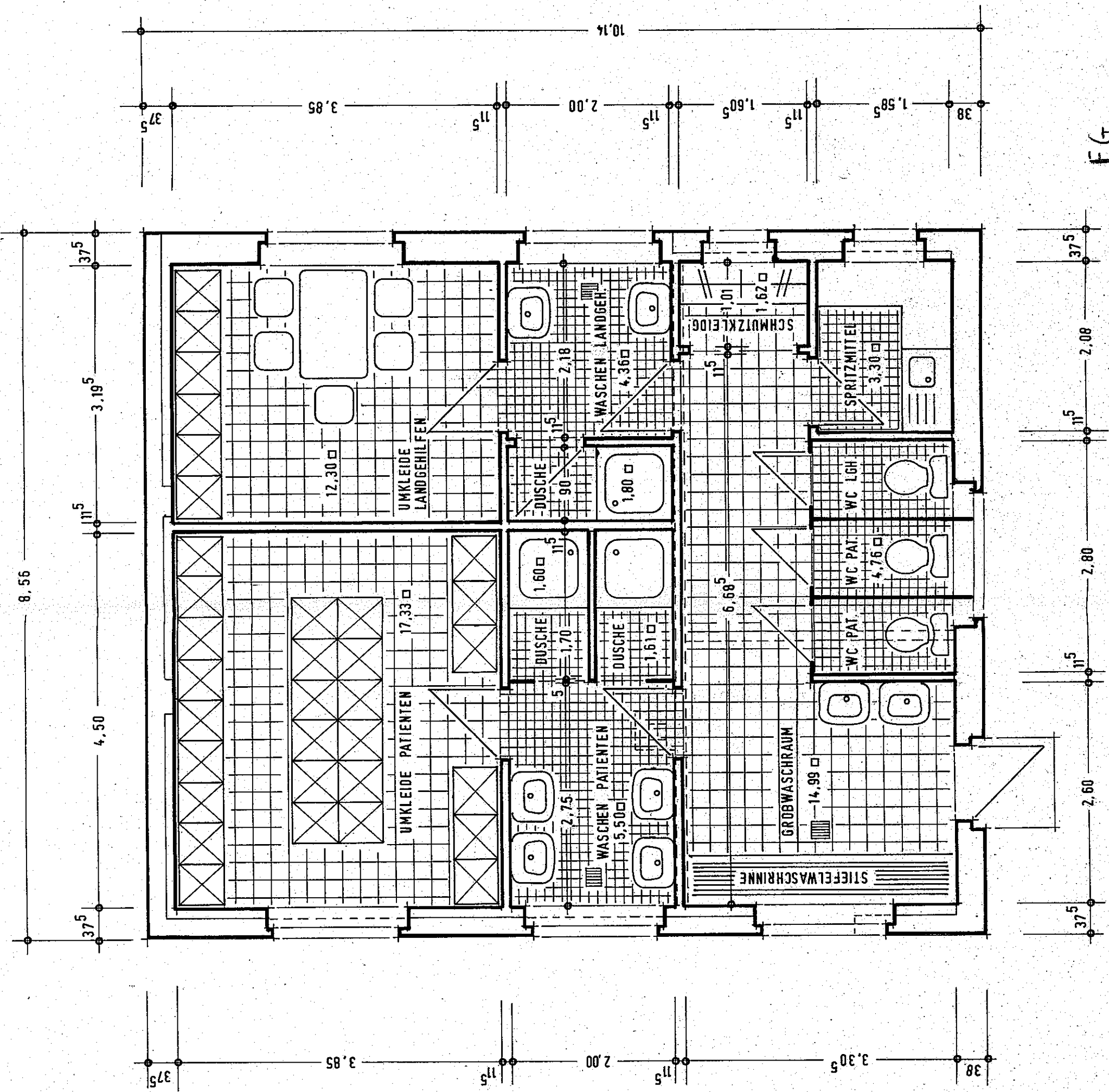

EG
1976